

Forni Tunnel a gas statici con nastro trasportatore in pietra refrattaria.

Static gas Tunnel ovens with conveyor belt in refractory stone.

TUNNEL STONE GAS - TSGAS

CARATTERISTICHE TECNICHE

- Nastro trasportatore con listelli in pietra refrattaria
- Bruciatori atmosferici con valvole di sicurezza
- Sistema di cottura statico
- Controllo digitale delle temperature del piano di cottura e del cielo separate
- Regolazione digitale o meccanica della velocità del nastro
- Ottimo isolamento
- Isolamento termico
- Cuscinetti autolubrificanti
- +30% di capacità di cottura rispetto ai forni convenzionali
- Cassetti raccogli-briciole rimovibili
- Massima temperatura di cottura 450 °C
- Serrandine regolabili

ACCESSORI

- Supporto del forno con ruote

OPTIONAL

- Kit encoder
- Rivestimento in vetro temperato con design personalizzabile
- Nastro di carico/scarico automatico motorizzato
- Vassoio in acciaio lato scarico

TECHNICAL SPECIFICATIONS

- Conveyor belt in refractory stone fillets
- Atmospheric burners with safety valves
- Static cooking system
- Digital top and bottom separate temperature control
- Digital or mechanic adjustable belt speed
- Excellent insulation
- Thermal insulation
- Self lubricating bearings
- +30% cooking capacity vs convection models
- Removable crumb collection drawers
- Max cook temp 450 °C
- Adjustable shutters

ACCESSORIES

- Oven support with wheels

OPTIONALS

- Encoder kit
- Tempered glass coating with custom design
- Automatic loading/unloading motorized belt
- Stainless Steel extension tray unloading side

VISTA DALL'ALTO
TOP VIEW

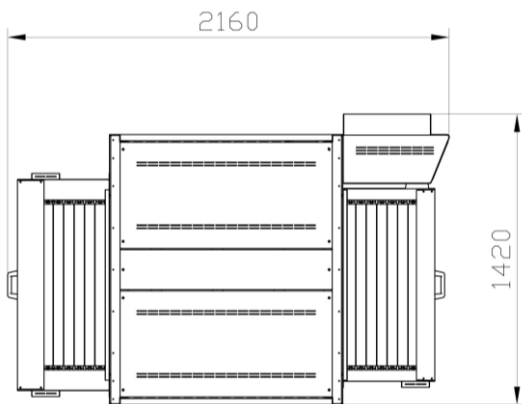



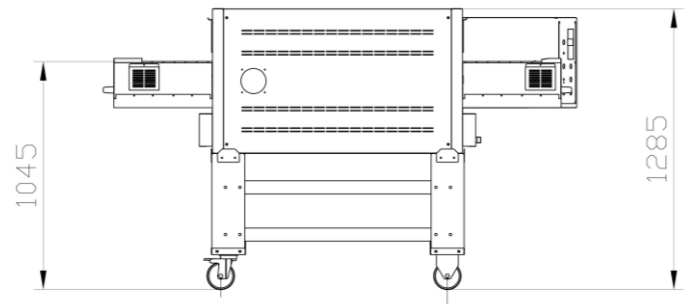









1 CAMERA + SUPPORTO ALTO
1 DECK + HIGH STAND



DATI TECNICI
TECHNICAL CHART



Tunnel	Dimensioni interne (cm)			Dimensioni esterne (cm)			Tappeto	Peso	Alimentazione	Potenza	Potenza	Assorbimento	Temperatura
	Internal dimensions (cm)			External dimensions (cm)			Conveyor	Weight	Supply	Power	Power	Absorption	Temperature
													
	A/H	L/W	P/D	A/H	L/W	P/D	L/W	KG	V/Ph/Hz	Kcal	Kcal/h	Ampere	°C
TSGAS - DECK	11	85	114	66	142	216	79	400	230/1/50-60	40420	20700		0/450
STSGAS - STAND				62	133	115		42					

Italforni Pesaro s.r.l.

Loc. Chiusa di Ginestreto • Via dell'Industria 130 • 61121 Pesaro (PU) • Italia
Tel +39 0721 48 15 15 - Fax +39 0721 48 24 53 info@italforni.it • www.italforni.it

